

User Quick Guide

快速使用指南

Model : 22U series

BOSTO[®]

1 开箱检查: Incoming inspection

A)检查产品外箱是否完好无损

Check the products box is in good condition;

B)阅读快速指南,检查配件盒中附件

Read the quick guide, check the accessories;



手绘屏Digital Panel



支撑脚Stand

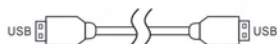

HDMI USB线Cable

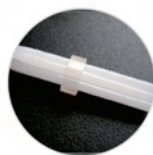

Stylues, Nibs, Metal ring 压感笔(笔芯, 笔芯更换器)



清洁布Cleaning cloth



驱动Driver CD

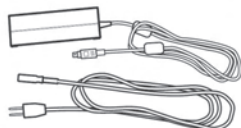

电源线DC Cable



说明书Quick guide



保修卡Warranty Card

注意：如果上述附件欠缺或损坏请速与您的经销商联系。

Note: Any lack or damage, Please contact local dealer ASAP

2 支撑脚安装及连接线使用说明

Stand usage and cable connection instruction

A)调整支撑脚角度 Stand angle adjusting :

为方便设计人员使用，可以通过拉起Stand顶部的扳扣释放机关向上或向下调整角度,整个过程可以单手操作完成;

To facilitate the designers to use, you can pull up the release of Stand at the top to adjust the angle by pull body up or down , the whole process can be completed with one hand operation;

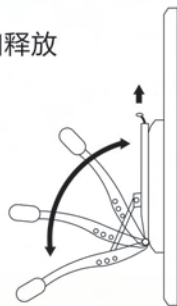

注意：在操作过程中，请选择合适的环境并注意保护好屏幕，人为损坏不属于保修范围；

Note: During operation, Please select the appropriate environment, attention to protecting the screen, man-made damage is not covered by the warranty;

B)线连接 Cable connection :

本产品配有HDMI线，电源线和USB线，使用时，首先连接好USB，视频线（VGA，HDMI,DVI）和电源线，连接电源到12V,2A-3.3A

This product is equipped with a HDMI line, power cord and USB cable, when used, first connect the USB, video cable(VGA, HDMI,DVI) and power cable, connect the power to 12V ,2-3 .3 A

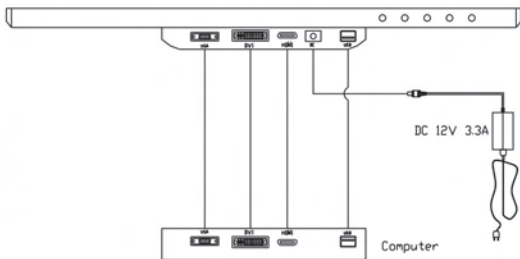

注意：建议使用HDMI与DVI高清连接，显示效果更稳定

Note: Recommend the use of high-definition HDMI or DVI connection, display more stable

3 驱动安装

Driver Installation

3-1 压感笔驱动安装 stylus driver installation

1. 确保设备接线正确后，启动计算机及液晶手绘屏；
 2. 将CD插入光驱，执行"SETUP"安装文件，根据电脑的操作系统选择合适的安装驱动；
 3. 当驱动安装完成后，手写小图标会出现在屏幕右下角，这表示手写驱动软件安装成功；放手写笔于屏幕，测试光标跟随手写笔的移动而移动，手写笔功能与鼠标功能类似，可完全取代鼠标的操作功能。
1. Ensure that the equipment wiring is correct, start the computer ;
 2. Insert the CD into the drive, execute "SETUP" installation file, according to the computer's operating system to choose the right drivers installed;
 3. When the driver installation is complete, the small hand icon appears in the lower right corner of the screen, which means hand-written driver software installed successfully ; put the stylus on the screen, test whether the cursor follow the stylus or not, stylus features and functionality similar to the mouse, you can completely replace the mouse operation function.

3-2 快捷键软件安装 Express key driver installing(available for 22UX only)

A: 软件安装 : Software installation:

1. 单击"安装"安装文件的光盘，根据计算机的操作系统选择相应的驱动程序安装；
Click "SETUP" installation files in the CD, according to the computer's operating system selects the corresponding driver to install ;
2. 使用USB数据线连接电脑与BOSTO手绘屏，打开快捷键软件，如果快捷键连接好后，快捷键菜单底部会有显示"DOWLOAD SUCCESS !"即证明驱动程序安装成功。
Use the USB line to connect the computer with the tablet monitor, run the express key software, there should have words of "USB Connected", that means the driver installed successfully.

B: 安装新程序: Setup New Program

1. 确认快捷键是否已与电脑连接（在菜单的底部会显示"USB CONNECTED"）；
confirmation of shortcut keys whether connected with computer
(at the bottom of the menu display "USB was connected") ;

2. 点击SETUP 键，在"NEW PROGRAM" 中输入软件名/编号（如"PHOTOSHOP"，在"EXPRESS KEY"栏中通过键盘输入指定的快捷键，在给按键定义之前(如"E")，然后在对应的右边栏目中输入备注(如:"橡皮擦")；click the SETUP button, in NEW PROGRAM input software name / number (such as "PHOTOSHOP", in EXPRESS Column KEY input through the keyboard shortcuts to specified, in the key definition before (such as " E "), then the corresponding right column input notes (such as: " the eraser ") ;

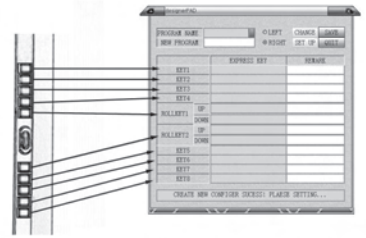

3. 四个滚轮快捷键使用说明：中间最靠近滚轮的两个按键可以设置四个滚轮快捷键，这四个快捷滚轮键通过二个按键切换；推荐客户把屏幕缩放，笔尖粗细缩放等功能设置在滚轮快捷键上；Four roller shortcut keys: among the most close to the roller two keys can switch four roller shortcuts; recommend customers to set screen zooming, nibs scaling functions on the roller shortcut ;
4. 设置完成后，按"SAVE" 键保存设置参数，按"QUIT" 退出。After setting is complete, press the "SAVE" key to save the setting parameters and then press " QUIT " to quit.

C : 更新某个程序Update Program

1. 当客户需要更改某个快捷键的定义，打开"KeyRollSet" 之后单击 "CHANGE" 去更改您想要更改的内容，更改完后保存即可；When customers need to change the shortcut key definitions, open the " KeyRollSet " then click " CHANGE " to change the content what you want to change and then click "save" key, the setting is complete ;
2. 使用时需注意左右手设定,如果是右手绘图,则需点选"Right" ；Pls pay attention to left and right hand setting, if it is the right hand to drawing, need to click the " Right " key ;
3. 您可以在不同的软件下保存不同的按键定义，只需在使用软件时，调出对应的文件名即可。You can be in a different software are preserved different key definition, when you use PS to draw, just Select the corresponding program name to upload.

注意：在安装软件前,请确认电脑是用的哪种操作系统，手写笔驱动软件暂时不支持苹果的操作系統

Note: Before installing the software, make sure which the operating system the computer is using? stylus-driven software is not support apple's MAC operating system

4 屏幕调整按键 Screen adjust buttons

1) 屏幕调整按键对应名称 corresponding name of Screen adjust buttons ;

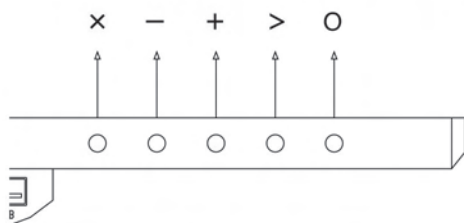

- x 退出/自动调节 Return/Auto
- 向下 Down
- + 向上 Up
- > 菜单/确认 Menu/Enter
- O 开关机 Power

2) VGA属于模拟信号，为达到更好的显示效果，在使用前请先按以下步骤调整：
VGA is analog signal, please using the following steps to adjust to achieve better display :

A) 打开16级灰阶图： Open the picture file of 16 gray-scale ;

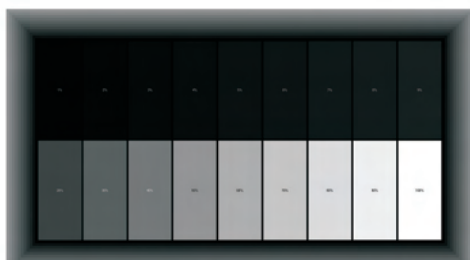

B) 按"菜单" ---按"向下"把光标移至"功能菜单"处并进入；

Press "Menu" --- click "down" to move the cursor to "function menu" and enter;

C) 分别选择"功能菜单"中的两个选项做自动调节；

Respectively selected "function menu" of the two options to do auto-adjust;

其它细节，如亮度，对比度及颜色则根据客户特别需要另外调节；

Other details, such as brightness, contrast and color are also adjusted according to customer special needs;

3) HDMI与DVI属于数字信号，无需对色彩进行调节；

HDMI and DVI is digital signal, no need to adjust the color;

5 手绘笔的使用 Stylus usage

- 1) 充电笔A款：在使用手绘笔前，需要对手绘笔充电，把笔插入充电器中，把充电器插入电脑USB孔，即可对笔进行充电，充电过程中，充电器LED灯红灯亮，当充满电后，LED显示蓝色(充电时间大约为2小时)，在使用过程中，可以根据笔上的LED灯显示确认是否需要充电；每次充满电后，大约可以连续使用80小时；
Charge pen A type: In the use of hand-drawn pen, you need to charge for the stylus, the stylus into the charger, the charger into the computer USB port; in the process of charging, the charger LED lights red, when fully charged, LED lights blue (charging time is approximately 2 hours), In use, you can determine whether stylus needs to be charged according to the LED lights color, each fully charged, stylus can be used continuously for 80 hours;
- 2) 启动：手绘笔的启动可以通过笔芯压力和笔身的按键启动，启动后LED灯亮显示；配合不同软件手绘，真实实现笔划的粗细，浓度变化，X/Y/Z 3D压感性能居世界领先水平；
Power on: Stylus could be power on through the side button click or the nibs pressure, LED lights display starts, Hand-painted with different software, to achieve real stroke thickness, concentration, X / Y / Z 3D pressure-sensitive performance reached world leading level;
- 3) 快捷键：手绘笔笔身上有一个快捷键,可以作为鼠标右键使用；
Express key: Stylus pen body has a express key, can be used as use the right mouse button；
- 4) 干电池笔B款：
使用时请按键或笔尖，电源指示灯亮后产品处于工作状态，按上键工作当产品停止使用8分钟后会自动关闭，按笔尖工作当产品停止使用15分钟后会自动关闭。
When using, please press the upper key or click the nib once to power on.the pen is working when the power indicator light on.the pen will power off after stop using for 8 minutes if you press the key to power on and will power off after using 15 minutes if you click the nib to power on.

注意：如果按上键或笔尖工作指示灯都不亮时表明电池电量不足，请更新AAAA干电池（如图2）

Notice: If the power indicator light can't work when press the upper key or click the nib, it means the battery is dead, please replace the battery. As figure 2 shows.

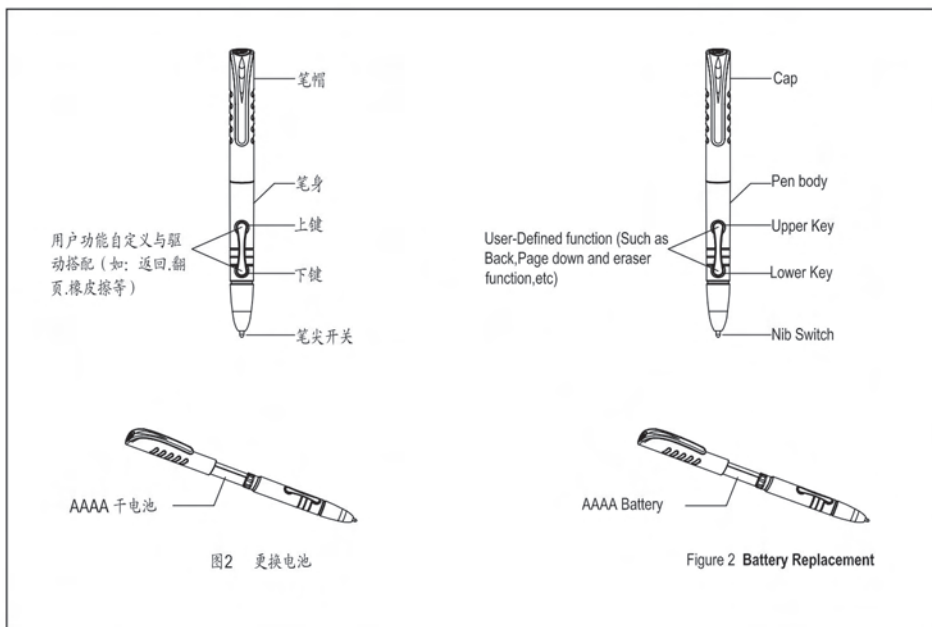

5) 更换笔芯：笔芯为易损件，长期使用过程中会有磨损，需要更换；更换时用配件中的换笔金属环夹住旧笔芯轻轻往外拉出，用手指捏住新的笔芯往里塞入即可；（注意在拉出及塞入笔芯时需与笔身保持水平）

Nibs replacement: Nibs is wearing parts, long-term use there will be wear and tear and need replacing; In replacement, use the metal ring clamped gently and pull out the old nibs, pinch the new nibs with fingers and stuffed inside ; (Note: The take out and stuffed nibs, the gestures and the pen body needs to maintain the same level)

